

JBC

www.jbctools.com

INSTRUCTION MANUAL



PHSEK

Preheater Set for PCBs
up to 13x13cm/5x5"

This manual corresponds to the following references:

PHSE-9KB (100V)

PHSE-1KB (120V)

PHSE-2KB (230V)

Packing List

The following items are included:

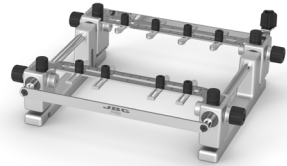

PHSE Preheater Unit 1 unit

PHSS Support 1 unit
Ref. PHS-SA



Console 1 unit
Ref. ACE-A

RJ45 Cable 1 unit
Ref. 0019914

Power Cord1 unit
Ref. 0024092 (100V)
0023715 (120V)
0023714 (230V)



Kapton Tape 1 unit
Ref. PH217

Thermocouple 2 unit
Ref. PH218

Manual 1 unit
Ref. 0026988

Features and Connections

Preheater Unit

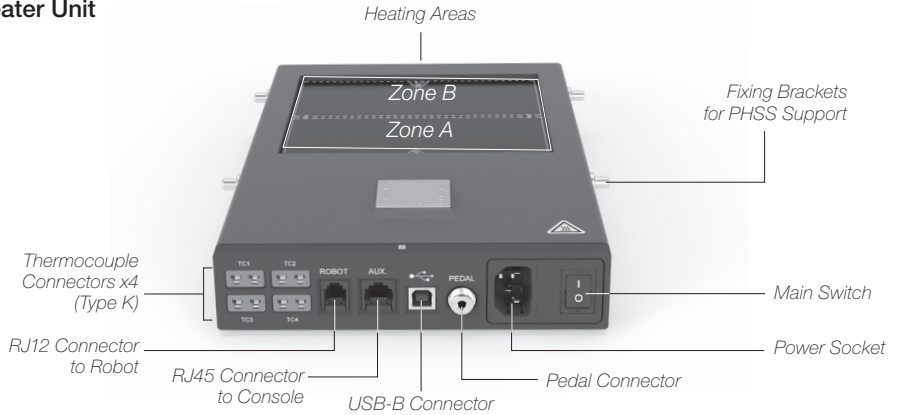

Console

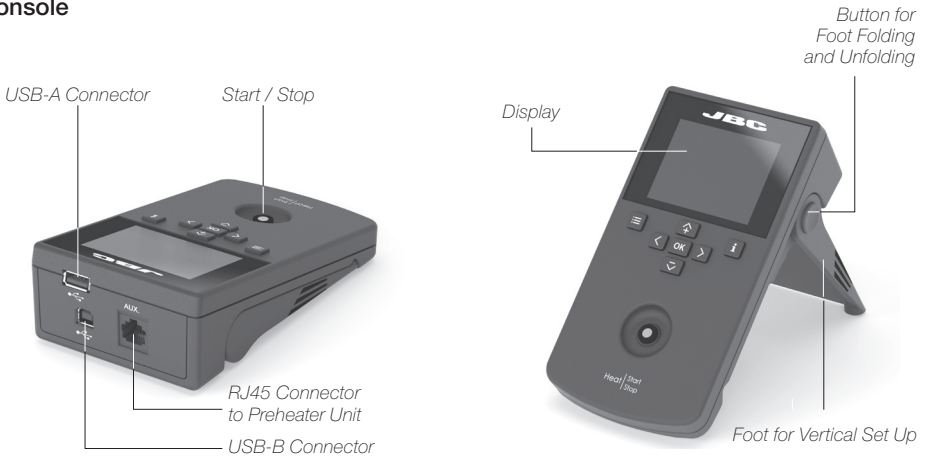

Support

Max. PCB Dimension (between clamps):
130x130 mm / 5x5 in, Thickness 6 mm / 0.236 in

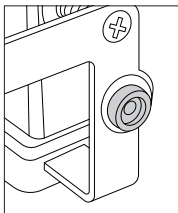

ESD Connector
(connect to ESD
Common Grounding
Point)

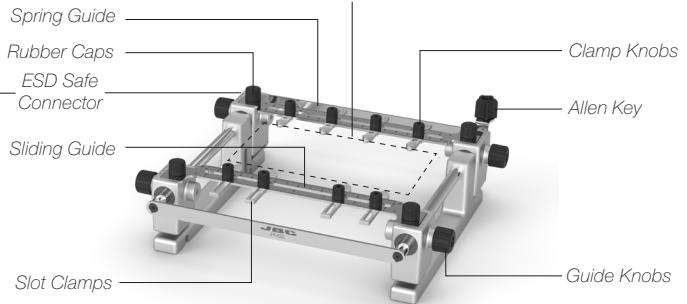

Height Adjustment

PHSS Support allows changing the height between the PCB and the preheater heating area. It can be chosen between 3 positions for the working height adjustment.

Low level

22 mm /
0.87 in

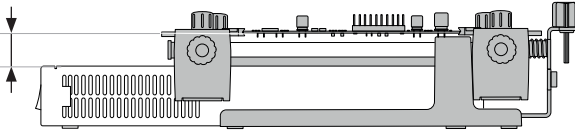

Unscrew these knobs to place the support in the lowest level



Medium level

45 mm /
1.77 in

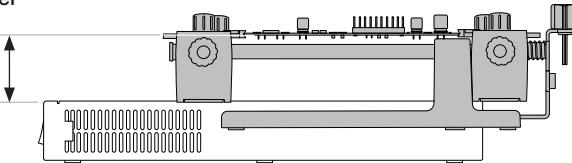

Use the fixing brackets to place the support in the medium and the high level



High level

65 mm /
2.56 in

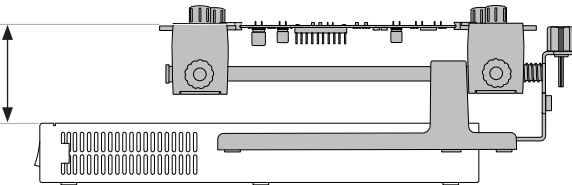

To change the height to the highest level, proceed as follows:

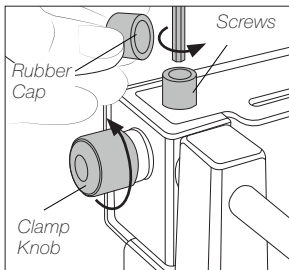

Remove the 4 clamp knobs and the 4 black rubber caps. Then remove the screws with an allen key (n° 3).

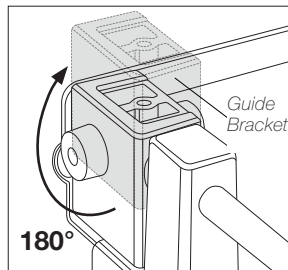

After removing both guides, rotate the guide brackets 180°.

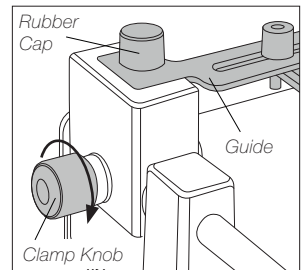

Place the guides, secure them with the screws, place the rubber caps and fix the clamp knobs.

Fast PCB Replacement

Move the spring guide backward to change PCBs of the same batch fast and easily.

Removing the PCB

Loosen the spring guide (1), push the PCB against the spring guide (2) and lift it out (3).

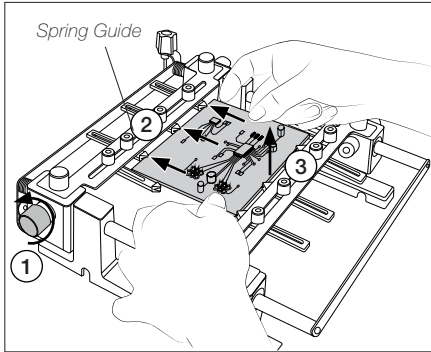

Placing another PCB

Position the new PCB (4) and tighten the spring guide knobs (5).

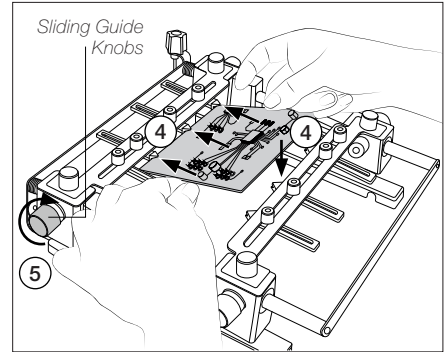

Reworking large PCBs

PCBs larger than the support can be placed onto the 4 rubber caps

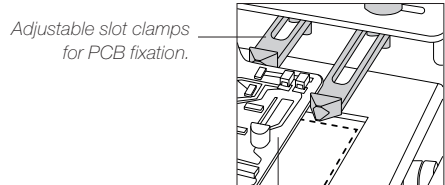
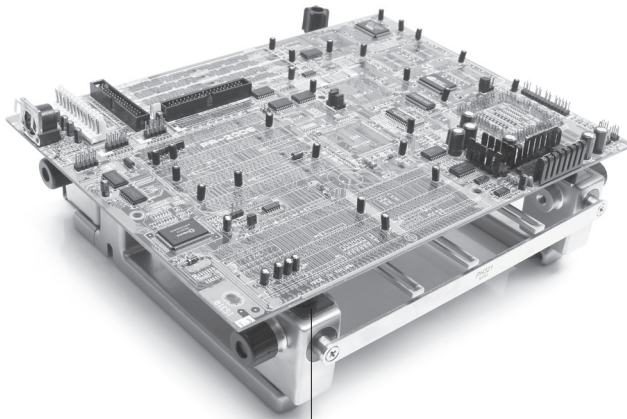

Adjustable slot clamps for PCB fixation.

Max. PCB dimension between clamps:
13x13 cm / 5x5 in,
thickness 6 mm / 0.236 in.

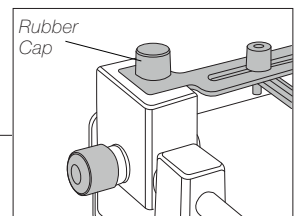

Rubber Cap

Work Display

The console offers an intuitive user interface, which provides quick access to station parameters.

Status Bar

Instant Power Supplied to Heater

Thermocouple Current Temp.

Status Indicator

Max. Heating Rate

TC1 Current and Selected Temperature

Thermocouple Selected Temp. and Mode
 · Control **C**
 · Protection **P**
 · Info

Station Information

Menu Options

***Original PIN: 0105**

General **Work mode** **Profile editor**

Graphics **Files** **Reset**

System Notifications (Status Bar)

- USB flash drive is connected.
- Station is controlled by a PC.
- Station is controlled by a robot.
- Station software update.
Press INFO to start the process.
- Warning.
Press INFO for failure description.
- Error. Press INFO for failure description, the type of error and how to proceed.

Available languages: English, Spanish, German, French, Italian, Portuguese, Japanese, Chinese, Russian and Korean.

Troubleshooting

Station troubleshooting is available on the product page at www.jbctools.com

Setting Thermocouples Function

Select *Thermocouples* from the *Work mode* menu to set them up.

The thermocouples (TC) can work in three different ways depending on what is needed.

- C** · Control: the unit maintains the selected temperature.
- P** · Protection: the Heater Unit stops if the TC reaches the selected temperature.
 - Info: the TC temperature is shown on the work display.

The TC1 is always working in Control mode for the *Temperature* mode as well as for *Profiles* mode. The temperature of each TC can also be selected from the work display.

Recommended Guidelines

1. Place the control thermocouple as near as possible to the component being worked on.
2. If there are any sensitive components, use a thermocouple as protection.
You can select the protection temperature in the *thermocouples* menu. If the selected temperature is reached, the Heater Unit will stop the process and a warning message will be shown.

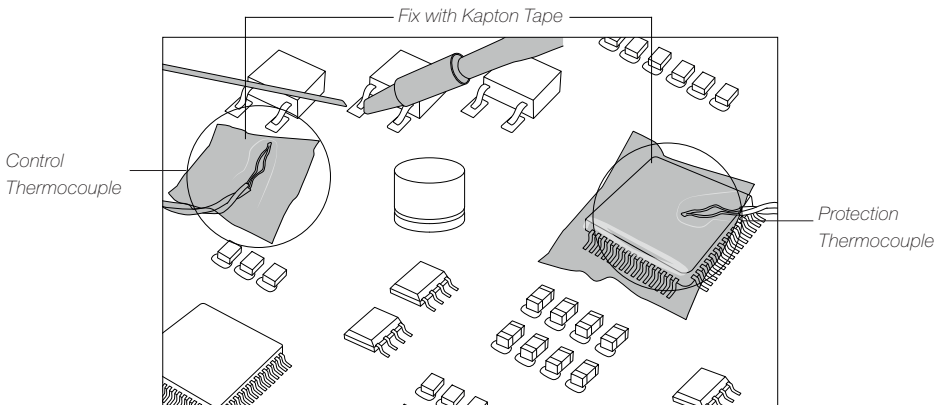

3. We don't recommend exceeding ramp-up rates over 3 - 4 °C / sec (5 - 7 °F / sec) so as to reduce the risk of thermal stress on the PCB.

Work Mode

Temperature Mode:

Select *Temp. mode* from the *Work mode* menu. In this mode, the heater unit maintains the selected temperature for the TC1 thermocouple as long as the other TC's do not reach the control/protection temperature limit.

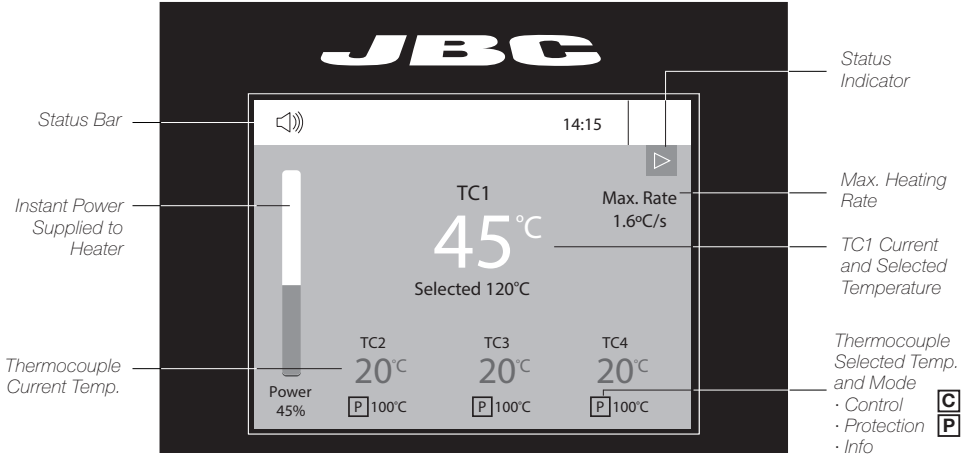

Working within the Temperature Mode the maximum heating rate value (*Max Rate*) can be defined (1).

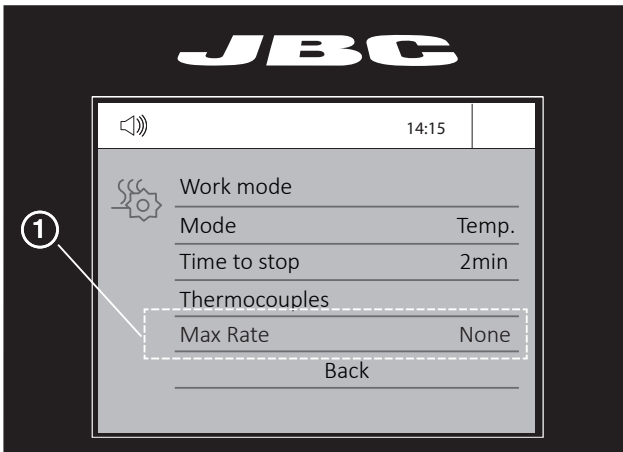

This function allows you to set a maximum value for the temperature increase per second when heating.

The maximum heating rate value can be set between 0.1°C/s and 2.0°C/s (2) or “None” if this function is not desired.

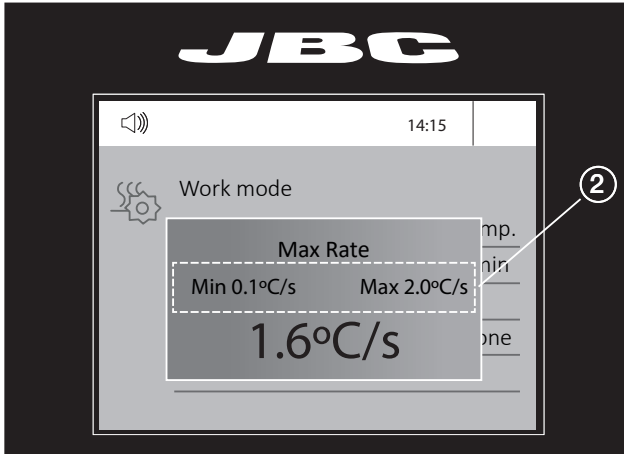

Power Mode:

Select *Power mode* from the *Work mode* menu. In this mode, the heater unit maintains the selected power as long as the thermocouples do not reach the control/protection temperature limit.

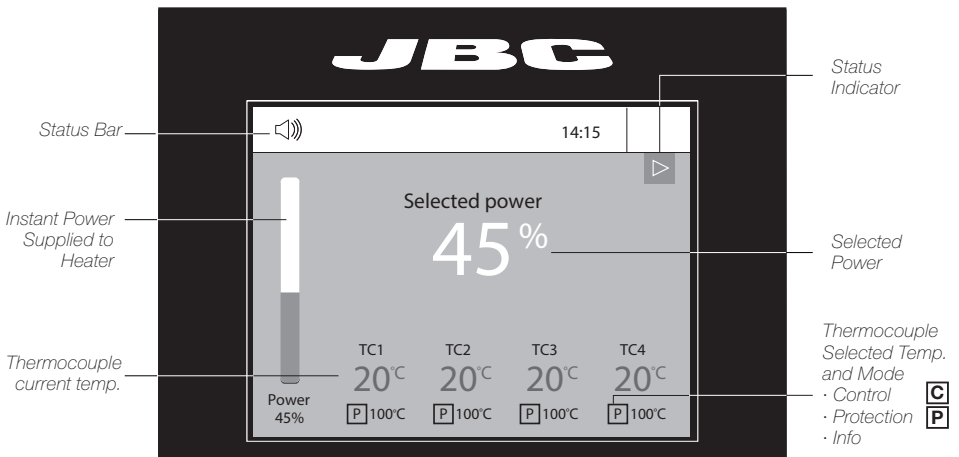

Profile Modes

Select *Profile Mode* from the *Work Mode* Menu. In this mode the heater unit regulates the temperature of the TC1 thermocouple according to the selected profile as long as the other TCs do not reach the control/protection temperature limit.

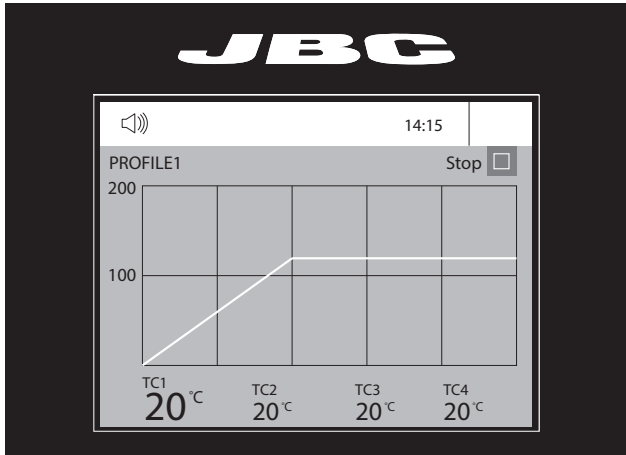

Teach Profile

For repetitive jobs it is also possible to run customized profiles without the thermocouple (TC). In order to do so, the *Teach profile* mode has to be executed before running any profile. It can be executed from the *Work mode* menu if the *Profiles* mode is selected. The first time, the thermocouple must be connected. Once the profile has been run to the end, the system has all the process data which you can save.

Once it is saved, you can run this profile without connecting the thermocouple (TC). The heating process will be the same as long as the same working conditions are respected.

The profiles which already have the data from the *Teach profile* are marked with this symbol 

These profiles can be run either with or without the Thermocouples. It can be chosen from the *Profiles* mode work screen:



Profile Editor



Profile Editor

The *Profile editor* can be opened from the main menu or from the *Profiles* mode work screen by pressing the 'OK' button.

In this mode, you can **edit** as many as 25 profiles of temperature.

Menu Options

- Add Point
- Delete Point
- Load Profile
- Save Profile
- Exit

JBC Predefined Profiles

There are 3 profiles predefined by JBC: A, B and C. The difference between them is the number of steps: 2, 3 or 4. The thicker your PCB is and the more layers it contains, the more steps are needed to obtain gradual warming.

Predefined profiles use the low position of the Support.

These profiles are not modifiable but they can be used as templates to create your own profiles.

JBC-A
2 steps

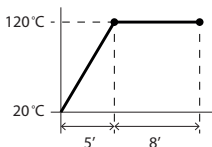

JBC-B
3 steps

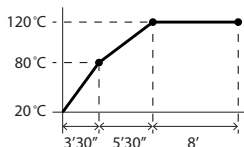

JBC-C
4 steps

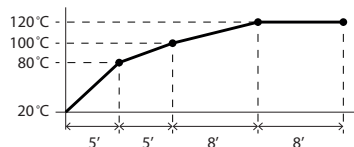

Reference-PCB specifications: FR4 1,6mm thick and 2 layers.

FR4 1,6mm thick and 6 layers.

FR4 2,2mm thick and 6 layers.

Process Analysis



Graphics

By pressing **Graphics** in the main MENU, the temperature of TC1 thermocouple and power figures in real time are displayed.

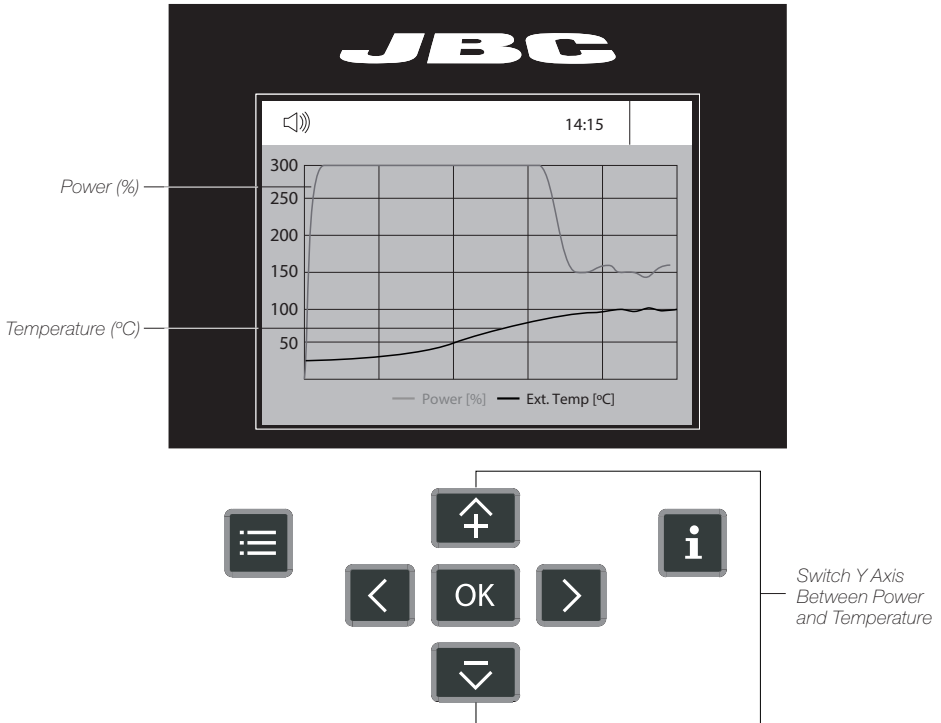

System Notifications

The following icons will be displayed on the screen's status bar.



USB flash drive is connected.



Device software update.
Press INFO to start the process.



Device is controlled by a PC.



Warning.
Press INFO for failure description.



Device is controlled by a robot.



Error.
Press INFO for failure description,
the type of error and how to proceed.

Files

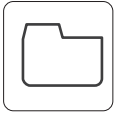

Files

Export Graphics

Insert a USB flash drive into the USB-A connector to save your soldering process in CSV format.

Export / Import Profiles

Insert a USB flash drive into the USB-A connector to export/import profiles.

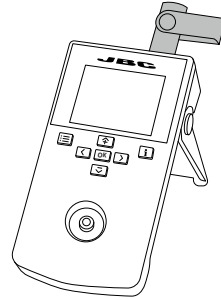

Update the Station Software

1. Download the JBC Update File from www.jbctools.com/software.html and save it on a USB flash drive. (Preferably one with no other files).

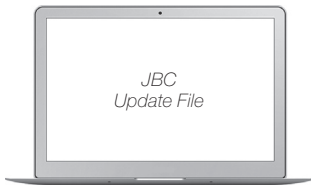

2. Insert the USB flash drive into the console. The icon  is displayed while updating.

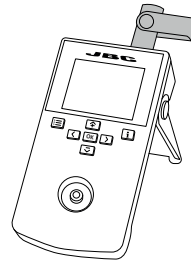

Working with Pedal

Press the pedal to start heating and press again to stop as if it were the button on the console. Once the Work Mode is set, the Heater Unit can work without the console using the pedal.

Pedal
Ref. P-405
(not included)

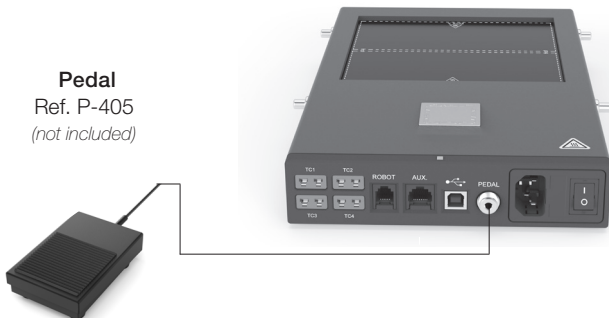

PHSE
Preheater Unit

Maintenance

- Before carrying out maintenance or storage, always allow the equipment to cool down.
- Check periodically that the equipment is clean.
- Use a damp cloth when cleaning. Alcohol can only be used to clean the metal parts.
- Only if it is absolutely necessary and if cleaning with isopropyl alcohol (IPA) is not enough, it is recommended to use a scraper to remove dirt in the glass area.
- Replace any defective or damaged parts. Use original JBC spare parts only.
- Repairs should only be performed by a JBC authorized technical service.
- A blown fuse can be replaced by the user itself.

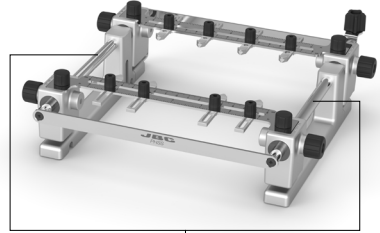

Clean periodically the Sliding Guide Axes

The fuse is located between the power supply connector and the on/off switch (1). To replace a blown fuse, proceed as described below.

⚠ Important: make sure that the preheater is disconnected from the power supply.

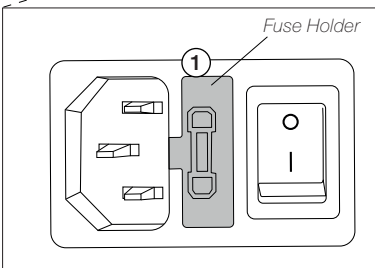

Pull out the fuse holder, if necessary use a tool to lever it off.

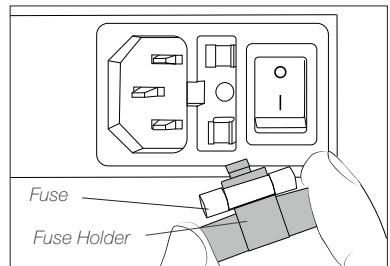

Take the blown fuse out and press the new one into the fuse holder. Finally clip the fuse holder back into place.

Reference for Replacement Fuse:

- PHSE-9B (100V), fuse T10A Ref. **0032666**
- PHSE-1B (120V), fuse T10A Ref. **0032666**
- PHSE-2B (230V), fuse T5A Ref. **0032687**

Safety



It is imperative to follow safety guidelines to prevent electric shock, injury, fire or explosion.

- Do not use the units for any purpose other than PCB preheating. Incorrect use may cause a fire.
- The mains cable must be plugged into approved bases. Make sure that it is properly grounded before use. When unplugging it, hold the plug, not the wire.
- The temperature of accessible surfaces may remain high after the unit is turned off. Handle with care.
- Do not leave the appliance unattended when it is on.
- Do not cover the ventilation grills. Heat can cause inflammable products to ignite.
- Heat can cause inflammable products to ignite even when out of sight.
- Be careful with the remains of liquid tin. In contact with the skin, it can cause burns.
- Avoid flux coming into contact with skin or eyes to prevent irritation.
- Be careful with the smoke produced when soldering.
- Keep your workplace clean and tidy. Wear appropriate protection glasses and gloves when working to avoid personal harm.
- This appliance can be used by children over the age of eight as well as persons with reduced physical, sensory or mental capabilities or lacking experience provided that they have been given adequate supervision or instruction concerning the use of the appliance and understand the hazards involved. Children must not play with the appliance.
- Maintenance must not be carried out by children unless supervised.

Specifications

PHSEK

Preheater Set for PCBs up to 13x13 cm / 5x5"

Ref. **PHSE-9KB** 100V. Input 100V 50/60Hz. Fuse T10A

Ref. **PHSE-1KB** 120V. Input 120V 50/60Hz. Fuse T10A

Ref. **PHSE-2KB** 230V. Input 230V 50/60Hz. Fuse T5A

- Total Net Weight: 4.8 kg / 10.6 lb
- Total Package Dimensions / Weight:
(L x W x H) 368 x 368 x 195 mm / 5.8 kg
14.5 x 14.5 x 7.7 in / 12.8 lb

PHSE Preheater Unit

- Maximum Power: 800W
- Heating Area: 65 x 135 mm / 2.56 x 5.31 in - 1 zone
130 x 135 mm / 5.12 x 5.31 in - 2 zones
- Ambient Operating Temperature: 10 - 40 °C / 50 - 104 °F
- Temperature Range: 50 - 250 °C / 120 - 482 °F
- Temperature Measurement: Thermocouple type K
Accuracy: ± 5 °C / ± 10 °F
- JBC Set Temperature Profiles: 3 profiles (2, 3 or 4 steps)
- User Profiles: 20 (up to 6 steps for each)
- Maximum Work Time: 600 min or indefinite
- Preheater Dimensions / Net Weight:
(L x W x H) 195 x 288 x 41.5 mm / 1.74 kg
7.68 x 11.34 x 1.63 in / 3.84 lb

PHSS Support

- Net Weight: 2 kg / 4.4 lb
- Support Dimensions (Low Position):
(L x W x H) 267 x 259 x 75 mm
10.5 x 10.2 x 3 in
- Support Dimensions (High Position):
(L x W x H) 267 x 259 x 96 mm
10.5 x 10.2 x 3.8 in
- Max. PCB Dimension (Between Clamps): 130 x 130 mm / 5.1 x 5.1 in
Thickness 6 mm / 0.236 in

Complies with CE standards.

ESD safe.

JBC

Warranty

JBC's 2 year warranty covers this equipment against all manufacturing defects, including the replacement of defective parts and labour.

Warranty does not cover product wear or misuse.

In order for the warranty to be valid, equipment must be returned, postage paid, to the dealer where it was purchased.

Get 1 extra year JBC warranty by registering here:
<https://www.jbctools.com/productregistration/>
within 30 days of purchase.



This product should not be thrown in the garbage.

In accordance with the European directive 2012/19/EU, electronic equipment at the end of its life must be collected and returned to an authorized recycling facility.

CE EAC UK
CA

www.jbctools.com