

# **JBC**

[www.jbctools.com](http://www.jbctools.com)

## **INSTRUCTION MANUAL**



### **APS**

Stand for

AP250 Manual-Feed Soldering Iron

This manual corresponds to the following reference:

**AP-SF**

## Packing List

The following items are included:



**Stand for AP250 Manual-Feed Soldering Iron ..... 1 unit**



**Stand Cable 1m ..... 1 unit**  
Ref. 0024227



**Sponge for Stand 48 x 26.5 mm .... 1 unit**  
Ref. S7034



**Brass Wool ..... 1 unit**  
Ref. CL6210



**Manual ..... 1 unit**  
Ref. 0027181

## Features and Connections

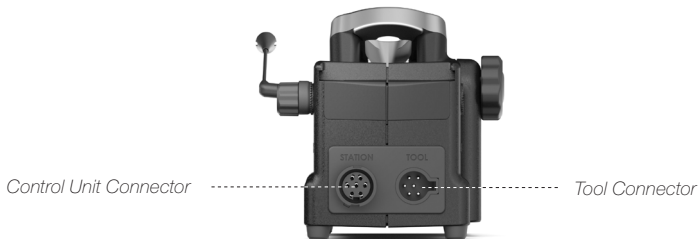
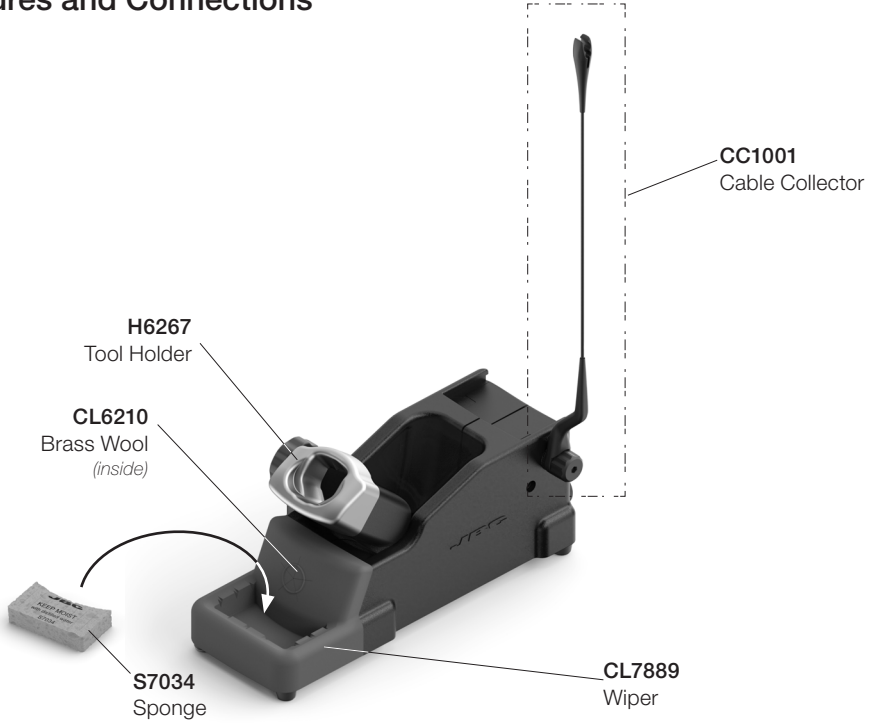

# Assembly

## Adjustable Cable Collector (CC1001)

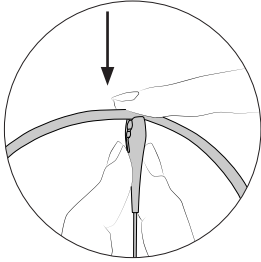

Insert the cable into the clip and then insert into the cable collector. Do not leave the cable longer than necessary to reach the work area freely.

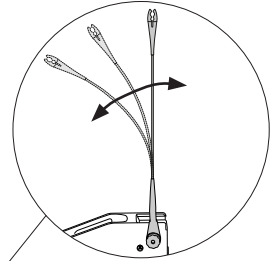

The cable collector is flexible. It accompanies and adapts to the movements during the soldering process.

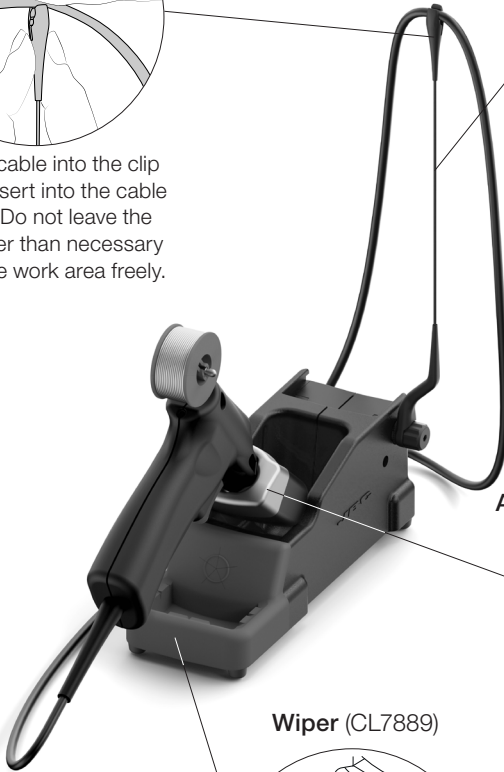

## Adjustable Tool Holder (H6267)

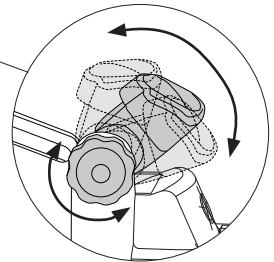

Adjust the tool holder angle to suit the work position.

## Wiper (CL7889)

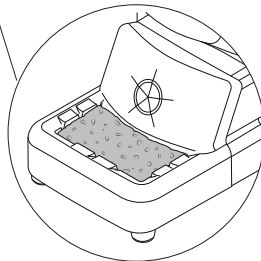

The wiper offers different ways to clean the cartridge tips. If desired use the included sponge.

## Wiper

The integrated wiper offers different ways to clean the cartridge tips.

### Tapping

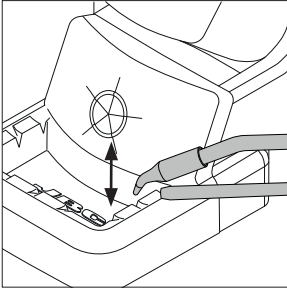

Tap gently to remove excess solder.

### Wiping

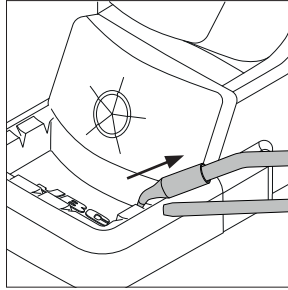

Use the slots to remove the remaining particles.

### Sponge

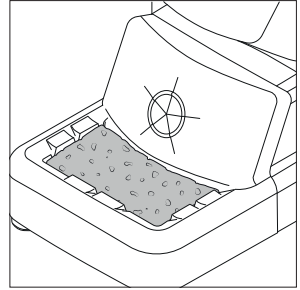

The softest cleaning method. Keep the sponge damp with distilled water when working to avoid tip wear.

## Wiper and Brass Wool Replacement

The wiper and brass wool can easily be removed for cleaning or replacement when they are worn.

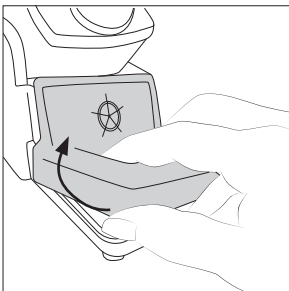

Lift the wiper at its front edge.

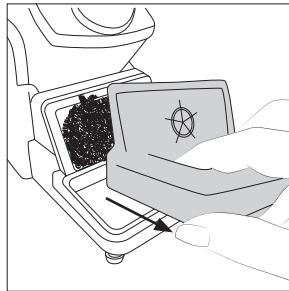

Remove the wiper by pulling it out.

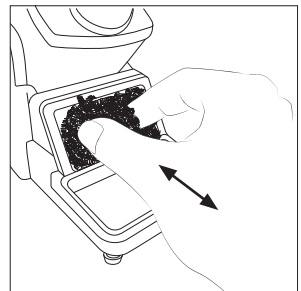

Replace the brass wool with a new one when it is worn out. Place the wiper back or replace them if desired.

## Accessories

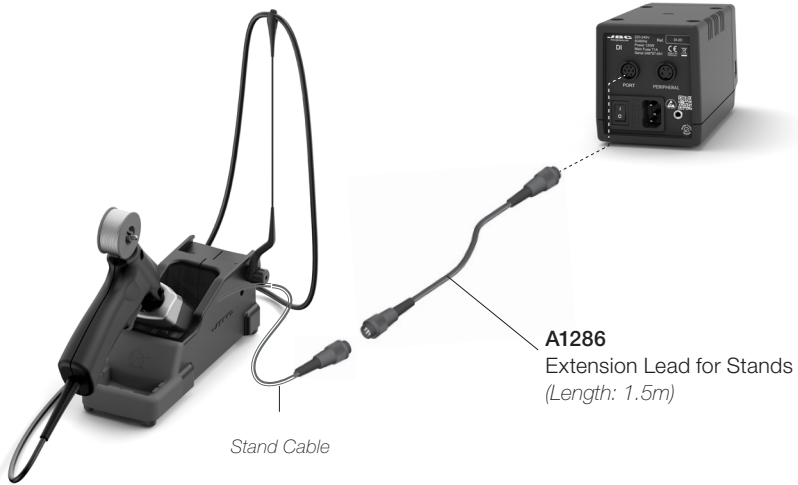

## Maintenance

Before carrying out maintenance or storage, always unplug the stand from the station and the tool.

- Use a damp cloth to clean the stand. Alcohol can be used only when cleaning the metal parts.
- Check periodically that the metal parts of the tool/stand are clean so that the station can check the tool's status.
- Periodically check all cables and tube connections.
- Replace any defective or damaged parts. Use original JBC spare parts only.
- Repairs should only be performed by a JBC authorized technical service.



## Safety



**It is imperative to follow safety guidelines to prevent electric shock, injury, fire or explosion.**

- Do not use the stand for any other purpose than soldering or rework.
- The power cord must be plugged into approved bases. Be sure that it is properly grounded before use. When unplugging it, hold the plug, not the wire.
- Do not work on electrically live parts.
- The tool should be placed in the stand when not in use in order to activate the sleep mode. The soldering tip, the metal part of the tool and the stand may still be hot even when the station is turned off. Handle with care, including when adjusting the stand position.
- Avoid the contact of flux with skin or eyes to prevent irritation.
- Be careful with the fumes produced when soldering.
- Keep your workplace clean and tidy. Wear appropriate protection glasses and gloves when working to avoid personal harm.
- Utmost care must be taken with liquid tin waste which can cause burns.
- This appliance can be used by children over the age of eight and also persons with reduced physical, sensory or mental capabilities or lack of experience provided that they have been given adequate supervision or instruction concerning use of the appliance and understand the hazards involved. Children must not play with the appliance.
- Maintenance must not be carried out by children unless supervised.

# Specifications

## APS

### Stand for AP250 Manual-Feed Soldering Iron

Ref.: **AP-SF**

- Includes	Sleep Mode
- Total Net Weight	1462 g / 3.22 lb
- Package Dimensions / Weight (L x W x H)	342 x 155 x 120 mm / 2022 g 13.46 x 6.10 x 4.72 in / 4.46 lb

Complies with CE standards  
ESD safe

# JBC

## Warranty

JBC's 2 year warranty covers this equipment against all manufacturing defects, including the replacement of defective parts and labour.

Warranty does not cover product wear or misuse.

In order for the warranty to be valid, equipment must be returned, postage paid, to the dealer where it was purchased.



This product should not be thrown in the garbage.

In accordance with the European directive 2012/19/EU, electronic equipment at the end of its life must be collected and returned to an authorized recycling facility.



[www.jbctools.com](http://www.jbctools.com)